

DV90

Dual View Trucks



**WACKER
NEUSON**
all it takes!



Safety redefined - dual view provides a clear view in any direction

The DV90 Dual View sets new standards in terms of operator and construction site safety, flexibility and economic efficiency. The dual view concept allows a comfortable and quick change of the seat position through a 180° turn of the entire operating and seat console. In this way, the operator always has perfect vision in the direction of travel - during transportation, loading and unloading. The rotation can be performed conveniently from the driver's seat by simply unlocking the seat console and turning it around.

- High driving position, high working position
- Optimal view for more safety
- Hydrostatic drive
- More ease of use thanks to the ergonomic rotary console
- Comfort cabin

DV90 Technical specifications

	Front tip skip	Swivel tip skip
Operating data		
Payload kg	9,000	9,000
Skip capacity - stroke l	3,750	3,300
Skip capacity - heaped l	4,600	4,350
Skip capacity - water measure l	2,400	2,050
Engine / Motor		
Engine / Motor manufacturer	DEUTZ	DEUTZ
Engine / Motor type	TD2.9 L4	TD2.9 L4
Engine / Motor	water-cooled 4-cylinder turbo-diesel	water-cooled 4-cylinder turbo-diesel
Engine performance kW	55.4	55.4
Displacement cm ³	2,900	2,900
Engine RPM rpm	2200	2200
Emissions	level 3b / Tier IV final	level 3b / Tier IV final
Traction drive	4WD / hydrostatic	4WD / hydrostatic
Travel speed max. km/h	30	30
Articulation angle °	28.3	29
Pendulum angle °	11	11
Turning radius mm	6,760	6,491
Gradeability %	50	50
Tires	500/60-22.5	500/60-22.5
L x W x H mm	4,622 / 2,420 / 3,307	4,622 / 2,420 / 3,307
Steering pump	axial piston pump	axial piston pump
Flow rate l/min	123	123
Operating pressure bar	480	480
Duty pump	gear pump	gear pump
Flow rate l/min	70.2	70.2
Operating pressure bar	240	240
Tank capacity l	80	80
Sound level (LwA) dB(A)	101	101

DV90 Dimensions

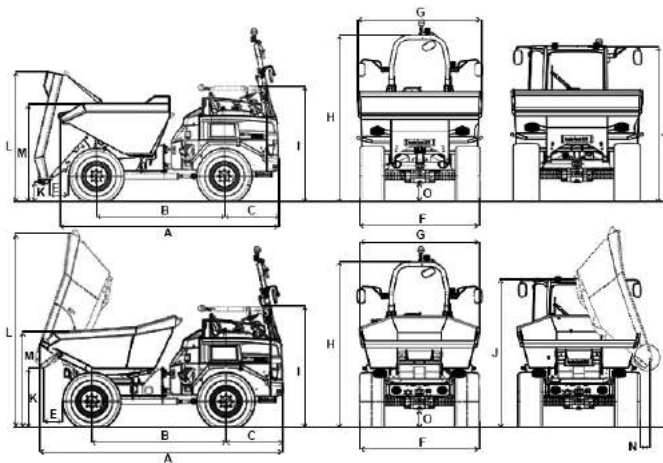

		Front tip skip	Swivel tip skip
A	Overall length ROPS	4,622 mm	4,891 mm
A	Overall length Cabin	4,622 mm	4,891 mm
B	Wheelbase	2,700 mm	2,700 mm
C	Rear overhang	1,157 mm	1,157 mm
E	Dumping distance	520 mm	457 mm
F	Width	2,420 mm	2,420 mm
G	Skip width	2,497 mm	2,453 mm
H	Height ROPS	3,382 mm	3,382 mm
I	Height ROPS tilted	2,405 mm	2,405 mm
J	Height Cabin	2,945 mm	2,945 mm
K	Dump height max.	357 mm	1,220 mm
L	Skip height tilted	2,723 mm	3,980 mm
M	Skip height not tilted	1,971 mm	2,230 mm
N	Dumping distance to the side		152 mm
O	Ground clearance	357 mm	358 mm
-	Dump angle	48 °	40.1 °

Please note: that product availability can vary from country to country. It is possible that information / products may not be available in your country. More detailed information on engine power can be found in the operator's manual; the stated power may vary due to specific operating conditions. Subject to alterations and errors excepted. Applicable also to illustrations.
Copyright © 2019 Wacker Neuson SE.