

KOMATSU®

WA320-8

EPA Tier 4 Final Engine

Australia & New Zealand Specifications

WHEEL LOADER

WA320



Photos may include optional equipment.

NET HORSEPOWER

123 kW/165 HP @ 2100 rpm

OPERATING WEIGHT

15,480 – 15,870 kg

BUCKET CAPACITY

2.3 – 3.2 m³

WALK-AROUND

WA320-8



Photos may include optional equipment.

NET HORSEPOWER

123 kW/165 HP @ 2100 rpm

OPERATING WEIGHT

15,480 – 15,870 kg

BUCKET CAPACITY

2.3 – 3.2 m³

HIGH PRODUCTION WITH LOW FUEL CONSUMPTION

Proven, Fourth Generation Hydrostatic Transmission:

- Quick Acceleration
- Dynamic Braking
- Variable Speed Traction Control
- Creeping Mode

Komatsu SmartLoader Logic helps reduce fuel consumption with no decrease in production.

A powerful **Komatsu SAA6D107E-3 engine** provides a net output of 123 kW 165 HP with up to 12% improved fuel consumption. This engine is EPA Tier 4 Final emissions certified.

Variable Geometry Turbocharger (VGT) is hydraulically actuated to provide optimum air flow under all speed and load conditions. This Tier 4 Final version has improved performance.

Komatsu Diesel Particulate Filter (KDPF) and Selective Catalytic Reduction (SCR) systems reduce particulate matter and NOx while providing automatic regeneration that does not interfere with daily operation.

Ample cooling capacity

- Auto-reversing fan is standard
- Wider core coolers

Fluid neutral or better

Combined fuel and DEF consumption is less than the WA320-6 fuel consumption.

Spacious cab provides the operator with improved comfort and visibility.

New high resolution monitor panel:

- Enhanced and intuitive on-board diagnostics
- Integrated with KOMTRAX Level 5
- Integrated with Komatsu Tier 4 Final technology

Rearview monitoring system is standard.

New high capacity air suspension seat with heat is standard.



Energy saving guidance:

- Six operator guiding messages
- Enhanced ecology gauge

Komatsu auto idle shutdown helps reduce idle time and operating costs.

Remote boom positioner can set kickout.

Versatile Parallel Z-bar (PZ) linkage for parallel lift.

Variable displacement piston pumps with Closed-Center Load Sensing System (CLSS) help reduce fuel consumption.

KOMTRAX® equipped machines send location, SMR and operation maps to a secure website or smart phone via wireless technology. Machines also relay error codes, cautions, maintenance items, fuel & Diesel Exhaust Fluid (DEF) levels, and much more.

Operator identification system tracks machine operation for up to 100 operators.

PERFORMANCE FEATURES

KOMATSU NEW ENGINE TECHNOLOGIES

New Tier 4 Final Engine

The Komatsu SAA6D107E-3 engine is EPA Tier 4 Final emissions certified, reduces fuel consumption, and provides exceptional performance. Based on Komatsu proprietary technologies developed over many years, this new diesel engine reduces nitrogen oxides (NOx) by more than 80% compared to Tier 4 interim levels.

Technologies Applied to New Engine

Heavy-duty After Treatment System

This new system combines a Komatsu Diesel Particulate Filter (KDPF) and Selective Catalytic Reduction (SCR). The SCR NOx reduction system injects the precise amount of Diesel Exhaust Fluid (DEF) to break down NOx into non-toxic water vapour (H₂O) and nitrogen gas (N₂).

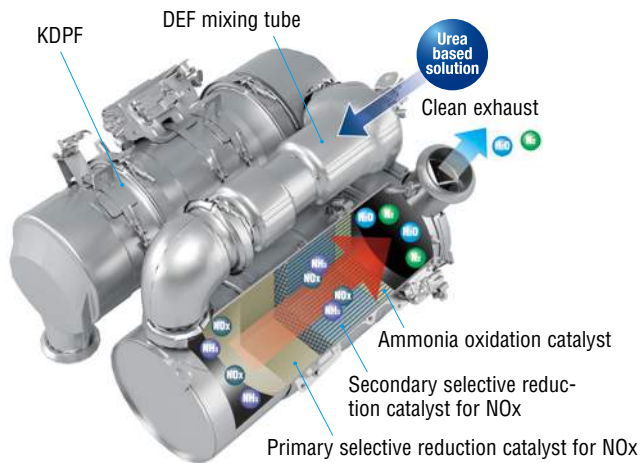

Heavy-duty Cooled Exhaust Gas Recirculation (EGR) System

The system recirculates a portion of exhaust gas into the air intake and lowers combustion temperatures, thereby reducing NOx emissions. EGR gas flow is lower for Tier 4 Final with the addition of SCR technology. The system dramatically reduces NOx, while helping cut fuel consumption below Tier 4 Interim levels.

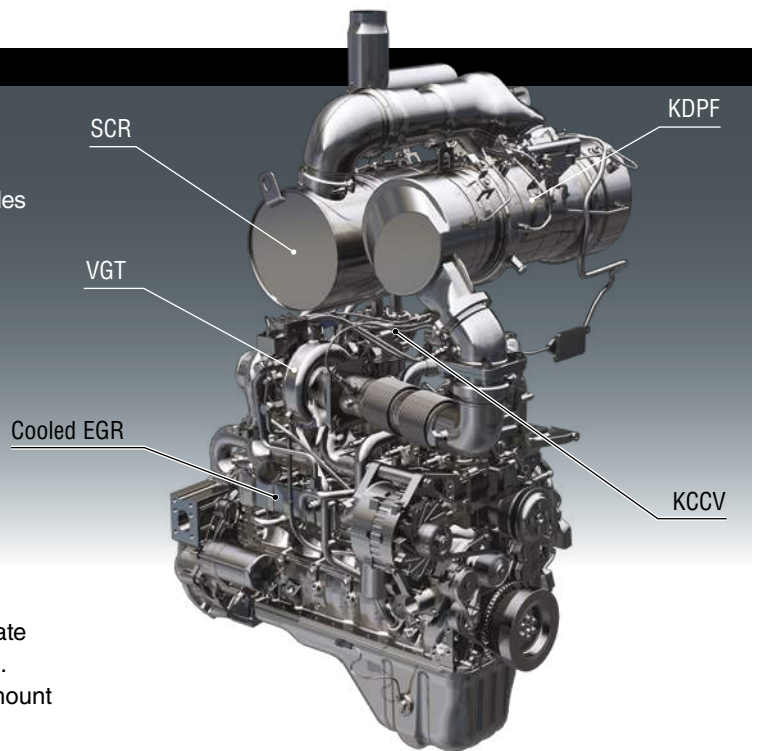
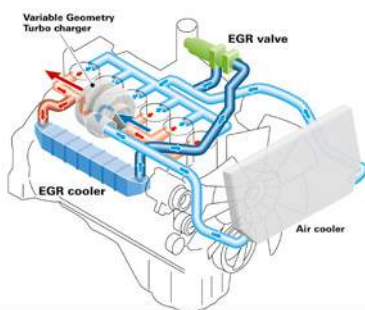

Advanced Electronic Control System

An improved electronic control system more effectively manages engine parameters such as airflow rate, EGR gas flow rate, fuel injection parameters, and after treatment function. The control system also provides enhanced diagnostics through the monitor panel. Additionally, managing information via KOMTRAX helps customers track required maintenance.

Variable Geometry Turbocharger (VGT) system

The VGT features proven Komatsu-designed hydraulic technology for robust and accurate control under all speed and load conditions for optimal engine performance. The VGT also provides precise exhaust temperature control for efficient KDPF regeneration. The Tier 4 Final version has a smaller impeller for improved performance.

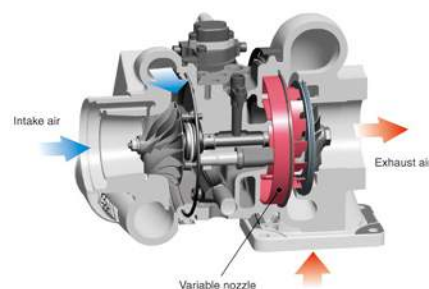

WA320-8

Heavy-Duty High-Pressure Common Rail (HPCR) fuel injection system

The system is specifically designed to achieve the optimal injection of fuel for near-complete combustion, which helps reduce Particulate Matter (PM) emissions.

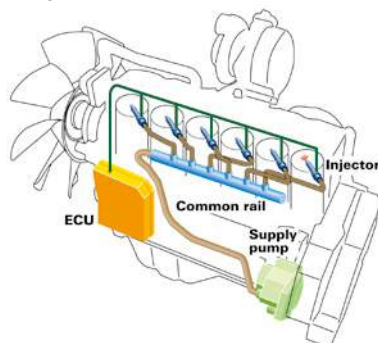

Komatsu SmartLoader Logic

The WA320-8 features Komatsu SmartLoader Logic, which controls engine torque to match machine demands. For example, engine torque needs are higher for digging in V-shape loading, but lower when driving with an empty bucket. This system optimizes the engine torque for all applications to minimise fuel consumption. Komatsu SmartLoader Logic functions automatically and doesn't interfere with operation, saving fuel without decreasing production.

Hydrostatic Transmission (HST)

The HST provides quick travel response and aggressive drive into the pile. Full auto-shifting eliminates any gear shifting and kick-down operation to allow the operator to concentrate on the digging and loading. The HST also acts as a dynamic brake to slow the loader. This dramatically extends the life of the wet disc brakes.

Variable Traction Control System

The variable traction control system is designed to adjust the traction control for each working condition. S-mode reduces tyre spin in slippery or snowy conditions. Auto-mode automatically optimises the tractive effort for various working conditions. Max traction provides the full, 100%, tractive effort.

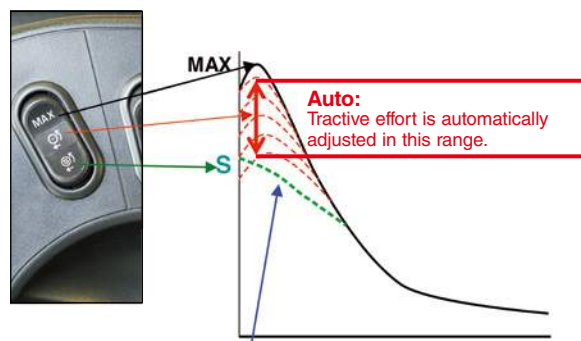

S-mode:
Improve tire slip ratio on snowy or slippery road condition

Creep Mode

Creep mode limits the travel speed in 1st speed range, while still allowing for full hydraulic flow.



Closed-Center Load Sensing System (CLSS)

The one-pump, two-motor system utilises a Closed-Center Load Sensing System (CLSS) pump. This system minimises hydraulic loss for better fuel economy by delivering only as much flow as the job requires.

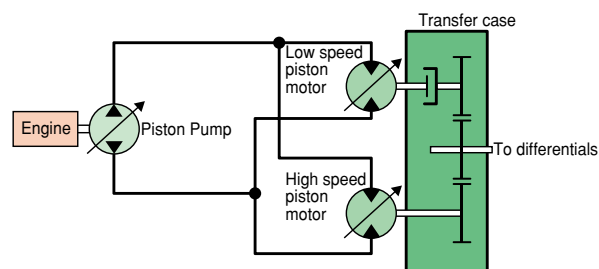

Komatsu Auto Idle Shutdown

In order to reduce unwanted idle time, Komatsu offers Komatsu auto idle shutdown. This function will shut the engine off and apply the parking brake and hydraulic lock after a preset idle time limit.



OPERATOR ENVIRONMENT



WA320-8

New Operator Seat

A new standard, heated, air-suspension seat provides enhanced support on rough roads and dampens machine vibrations, providing a more comfortable ride for the operator. The angle of the armrest is fully adjustable for optimum operator comfort. A secondary F-N-R switch is incorporated into the standard multi-function mono lever.



Low Noise Design

Operator's ear noise level: 68 dB(A)
Dynamic noise level (outside): 105 dB(A)

The large ROPS/FOPS cab is mounted with Komatsu's unique viscous mounts. The low-noise engine, hydraulically-driven fan, and hydraulic pumps are mounted with rubber cushions, and the cab sealing is improved to provide a quiet, low-vibration, comfortable operating environment.



Tiltable / Telescopic Steering Wheel

The operator can tilt and telescope the steering wheel to allow maximum comfort and control. The two-spoke steering wheel allows maximum visibility of the monitor panel and the forward work environment.



Increased Cab Storage Area

The WA320-8 cab features a storage box on each side of the cab to allow the operator to store items such as a beverage or lunch.





Standard Rear View Monitoring System

The dedicated full-colour monitor on the right side of the cab provides the operator with a rear view from the machine. This monitor can be always on or only on when the loader shifts into reverse. Guidelines provide the operator with visual cues for the width of the loader.



Engine Shutdown Secondary Switch

The engine stop switch enables machine shutdown when accessing the key switch is not possible.

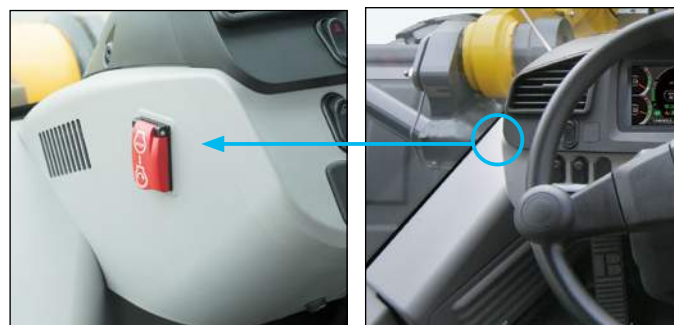

Auxiliary Input (MP3 Jack) 12 V Outlets

An Aux input for audio devices is standard as well as two 12 volt outlets. These are all located on the rear wall of the cab.

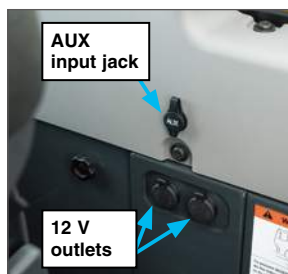

Emergency Stop

The cabin E-Stop provides the operator with immediate access from the operator's seat and is located on the RHS forward cabin pillar.



OPERATOR ENVIRONMENT



Easy Entry and Exit

The WA320-8 has an inclined ladder with wide steps and well-placed hand holds to ease entry and exit from the cab. The door latch can be reached from ground level to ease opening and closing the door.

Electronically Controlled Suspension System

The standard Electronically Controlled Suspension System or ride control system uses an accumulator, which absorbs some of the shock in the boom arm, giving the operator a much smoother ride. This reduces operator fatigue and reduces material spillage during load and carry operations. Ride control is speed sensitive and the activation speed can be adjusted in the monitor panel.

Multi-Function Mono Lever (Optional)

The multi-function mono lever with EPC control for 3rd spool is standard. It includes a forward-neutral-reverse switch for quick and easy travel. Third spool attachments can be set to continual or proportional control via the monitor panel allowing the operator to control the boom, bucket and attachment all with a single lever.



Remote Boom Positioner

The operator can set the upper boom limit from the cab.

Remote boom positioner



Attachment selector switch

Attachment Selector Switch

Coupler equipped machines which use buckets and forks require a different flat level setting when switching between attachments. The attachment selector switch found in coupler equipped machines tells the loader which flat level to use.

INFORMATION & COMMUNICATION TECHNOLOGY

New High Resolution LCD Monitor Panel

The new 7" colour LCD monitor panel displays operational information, ecology guidance and maintenance records. Information such as traction mode, coolant temp, oil and fuel levels are easy to read to keep the operator informed of the machine's settings and conditions.

Machine monitor

- 1 LCD unit
- 2 LED unit
- 3 Engine tachometre
- 4 Speedometre
- 5 Ecology gauge
- 6 Air conditioner display
- 7 Traction level
- 8 Engine coolant temperature gauge
- 9 Fuel gauge
- 10 HST oil temperature gauge
- 11 Variable speed display
- 12 Message pilot lamp
- 13 Pilot lamps
- 14 DEF level gauge

Switch panel

- 1 Air conditioner switches / Numeral key pad
- 2 Function switches

Visual user menu

Pressing the menu button on the switch panel accesses the user-menu screen. The menus are grouped by function, with easy-to-understand, intuitive icons for easier machine operation.

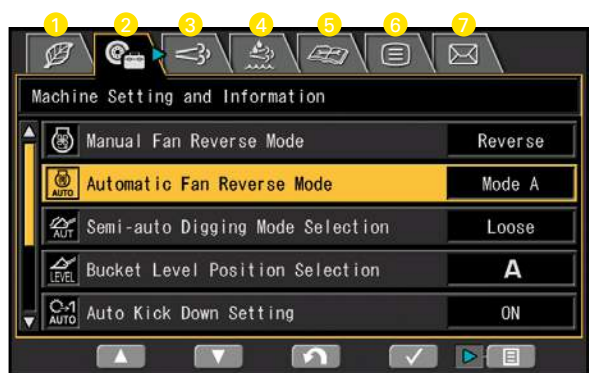
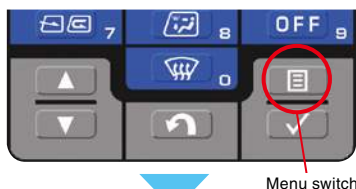

- 1 Energy saving guidance
- 2 Machine settings
- 3 Aftertreatment devices regeneration
- 4 SCR information
- 5 Maintenance
- 6 Monitor setting
- 7 Mail check

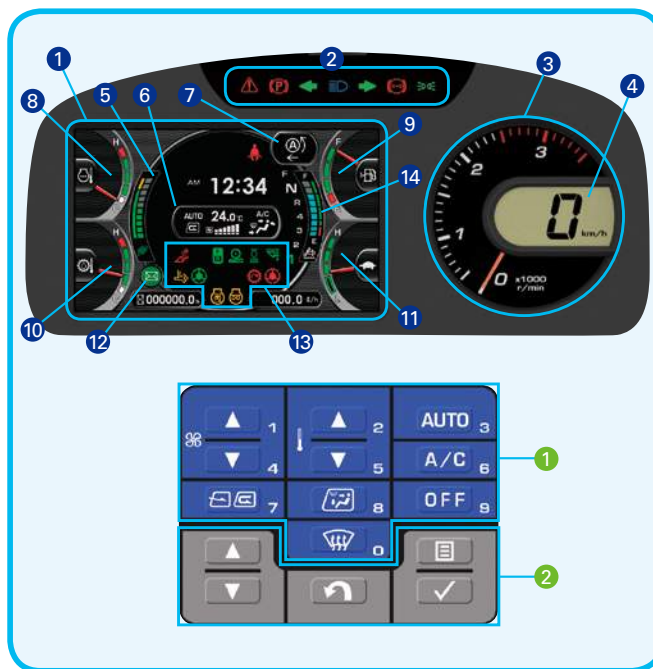

Operator identification function

An operator identification (ID) code can be set for each operator, and used to manage operation information of individual machines through KOMTRAX. Data sent from KOMTRAX can be used to analyse operation status by operator job, as well as by machine.



Monitor Panel with troubleshooting function minimises downtime

Various metres, gauges and warning functions are centrally arranged on the monitor panel. The monitor simplifies start-up inspection and warns the operator with a lamp and buzzer if any abnormalities occur. Warnings are indicated in four levels, which the operator must acknowledge and clear. Replacement times for oil and filters are also indicated.



MAINTENANCE FEATURES

WA320-8



Automatic Greasing System

4 kg reservoir.



Side-opening Gull-wing Engine Doors

The large, gull-wing-type engine doors require minimal effort to open and close, thanks to gas assisted struts. The doors make access and daily maintenance easy. Large steps on each side of the frame also enhance accessibility.



Swing-Out Type Cooling Fan and Wide Core Radiator

The cooling fan swings out for easier cleaning. The coolers feature wide-spaced cooling fins to reduce clogging.



Auto Reversing Fan

The engine cooling fan is hydraulically driven. It can be set to reverse automatically during operation. Fan reverse mode and timing can be controlled through the monitor.



DEF Tank

The DEF tank is easily accessed behind the RH side ladder. An external sight gauge helps prevent overflow and spillage while refilling.



Battery Isolation Switch

The battery isolation switch is located on the right side of the machine. This can be used to disconnect power when performing service work on the machine.



Engine Compartment

The WA320-8 engine compartment is designed for easy serviceability. Placement of maintenance items, such as filters, dipsticks, and oil-fill locations are laid out for easy-to-reach, ground-level access.

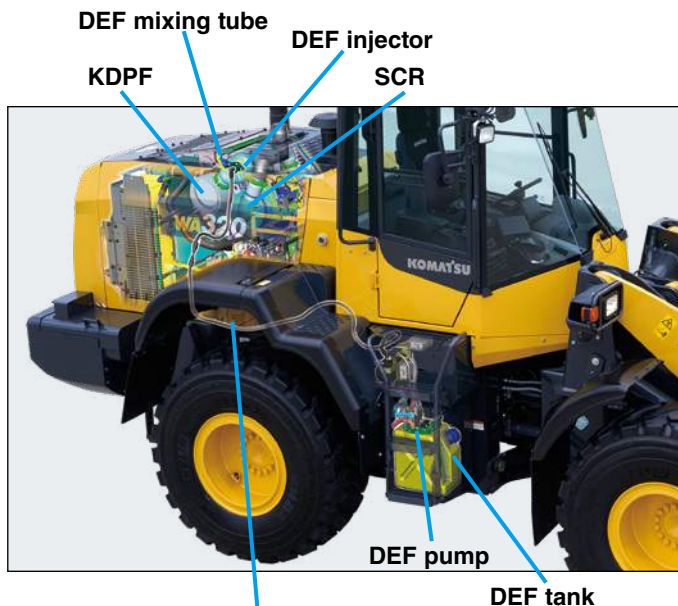

Engine oil dipstick Fuel filter Engine oil fill

Rear Full Fenders

The rear fenders open upward and use gas-assist struts, which require low lift force. The fenders swing up with the gull-wing doors to give the technician easy access to the engine compartment. Mud flaps are also included on the rear fenders.



Cab Air Filter

The inside and outside air filters can be replaced easily without the need for tools. The outside filter is located behind a lockable door for security.



Inside air filter Outside air filter

Engine Air Cleaner and Pre-Cleaner

Turbo II centrifugal type pre-cleaner for extended filter life and engine protection is standard.



Wheel Chocks

Steel type wheel chocks for safe parking during service work.



Maintenance Information

“Maintenance time caution lamp” display

When the time before required maintenance dips below 30 hours*, the maintenance-time monitor appears. Pressing the menu switch displays the maintenance screen.

* : The setting can be changed within the range between 10 and 200 hours.



Maintenance screen

Supports DEF level and refill timing

The DEF level gauge is displayed continuously on the monitor panel. In addition, when the refill timing is reached, the DEF-low-level icon appears to alert the operator.



DEF level gauge

DEF low level guidance

KOMTRAX EQUIPMENT MONITORING

GET THE WHOLE STORY WITH
KOMTRAX[®]

✓ WHAT

- KOMTRAX is Komatsu's remote equipment monitoring and management system
- KOMTRAX **continuously monitors and records** machine health and operational data
- Information such as fuel consumption, utilisation, and a detailed history **lowering owning and operating cost**

✓ WHEN

- Know when your machines are **running or idling** and make decisions that will improve your fleet utilisation
- Detailed movement records ensure you know when and where your equipment is moved
- Up to date records allow you to **know when maintenance is due** and help you plan for future maintenance needs

✓ WHERE

- KOMTRAX data **can be accessed virtually anywhere** through your computer, the web or your smart phone
- Automatic alerts keep fleet managers up to date on the latest machine notifications

✓ WHY

- Knowledge is power - **make informed decisions** to manage your fleet better
- Knowing your idle time and fuel consumption will help maximise your machine efficiency
- **Take control of your equipment** - any time, anywhere

✓ WHO

- KOMTRAX is **standard** equipment on all Komatsu construction products



KOMTRAX[®]

For construction and compact equipment.

KOMTRAX Plus[®]

For production and mining class machines.

SPECIFICATIONS



ENGINE

ModelKomatsu SAA6D107E-3*
 Type..... Water-cooled, 4-cycle
 Aspiration Variable geometry turbo-charged,
 after-cooled, cooled EGR
 Number of cylinders 6
 Bore107 mm
 Stroke124 mm
 Piston displacement..... 6.69 ltr
 Governor All-speed, electronic
 Horsepower:
 SAE J1995 Gross 127 kW 170 HP
 ISO 9249 / SAE J1349 Net 123 kW 165 HP
 Rated rpm 2100 rpm
 Max power - ISO 14396..... 126 kW 169 HP @ 1900 rpm
 Fan drive method for radiator cooling..... Hydraulic
 Fuel system Direct injection
 Lubrication system:
 Method.....Gear pump, force-lubrication
 Filter Full-flow type
 Air cleaner Dry type with double elements and
 dust evacuator, plus dust indicator

*EPA Tier 4 Final emissions certified



TRANSMISSION

Transmission Hydrostatic, 1 pump, 2 motors
 with speed range select

Travel speed	Forward	Reverse
1st	1.0 - 13.0 km/h	1.0 - 13.0 km/h
2nd	13.0 km/h	13.0 km/h
3rd	18.7 km/h	18.7 km/h
4th	38.0 km/h	38.0 km/h

Measured with 20.5-R25 tyres



AXLES AND FINAL DRIVES

Drive system..... Four-wheel drive
 Front Fixed, semi-floating
 Rear.....Center-pin support, semi-floating,
 24° total oscillation
 Reduction gear.....Spiral bevel gear
 Differential gear..... Torque proportioning
 Final reduction gear Planetary gear, single reduction



BRAKES

Service brakes Hydraulically actuated,
 wet disc brakes actuate on four wheels
 Parking brake ... Wet, multi-disc brake on transfer output shaft
 Secondary brake..... Parking brake is commonly used



STEERING SYSTEM

Type.....Articulated type, fully-hydraulic power steering
 Steering angle 38.5° each direction (40° to max end stop)
 Minimum turning radius at
 the center of outside tyre 5380 mm



HYDRAULIC SYSTEM

Steering system:
 Hydraulic pump Piston pump, in common with
 loader control
 Capacity 180 ltr/min at rated rpm
 Relief valve setting..... 20.6 MPa 210 kgf/cm²
 Hydraulic cylinders:
 Type Double-acting, piston type
 Number of cylinders 2
 Bore x stroke 70 mm x 453 mm
 Loader control:
 Hydraulic pump Piston pump, in common with
 steering system
 Capacity 180 ltr/min at rated rpm
 Relief valve setting..... 30.4 MPa 310 kgf/cm²
 Hydraulic cylinders:
 Type Double-acting, piston type
 Number of cylinders—bore x stroke:
 Lift cylinder 2- 120 mm x 729 mm
 Bucket cylinder 1- 150 mm x 558 mm
 Control valve 2-spool type
 Control positions:
 Boom Raise, hold, lower, and float
 Bucket..... Tilt-back, hold, and dump
 Hydraulic cycle time (rated load in bucket)
 Raise..... 6.3 sec
 Dump 1.9 sec
 Lower (Empty)..... 3.5 sec



SERVICE REFILL CAPACITIES

Cooling system..... 35.1 ltr
 Fuel tank..... 245 ltr
 Engine 23 ltr
 Hydraulic system..... 92 ltr
 Axle front 27 ltr
 Axle rear 25.5 ltr
 Transfer case..... 5.8 ltr
 DEF tank..... 14 ltr



BUCKET SELECTION GUIDE

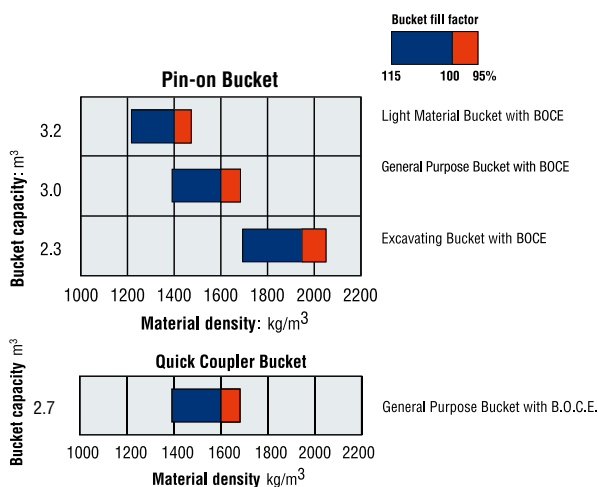

SPECIFICATIONS



DIMENSIONS

Measured with 20.5-R25(L3) tyres, ROPS/FOPS cab

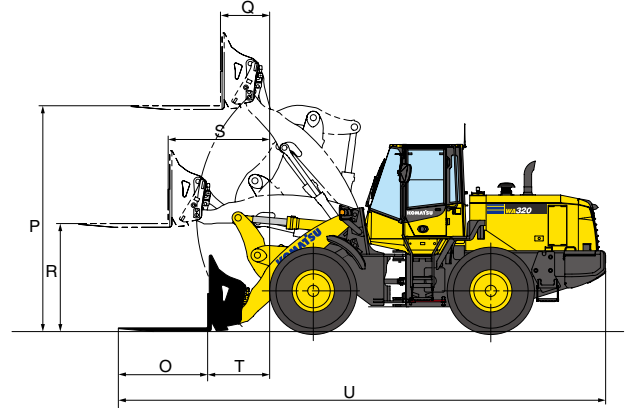
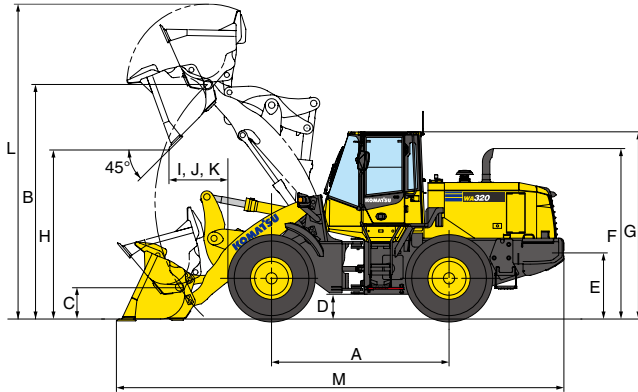

Tread		2050 mm
Width over tyres		2590 mm
A Wheelbase		3030 mm
B Hinge pin height,	Standard Boom	4005 mm
max. height	High Lift Boom	4545 mm

C Hinge pin height,	Standard Boom	545 mm
carry position	High Lift Boom	705 mm
D Ground clearance		425 mm
E Hitch height		1085 mm
F Overall height, top of the stack		3040 mm
G Overall height, ROPS cab		3200 mm

BUCKET

	General Purpose Bucket w/ Pin On		Light Material Bucket w/ Pin On		Excavating Bucket w/ Pin On		General Purpose Bucket w/ Quick Coupler		High Lift General Purpose Bucket w/ Pin On	
	B.O.C.E.	B.O.C.E.	B.O.C.E.	B.O.C.E.	B.O.C.E.	B.O.C.E.	B.O.C.E.	B.O.C.E.	B.O.C.E.	B.O.C.E.
Bucket capacity: heaped	3.0 m ³	3.2 m ³	2.3 m ³	2.7 m ³	2.3 m ³	2.4 m ³	2.2 m ³	2.3 m ³	2.3 m ³	2.3 m ³
struck	2.4 m ³	2.8 m ³	1.9 m ³	2.2 m ³	1.9 m ³	2.2 m ³	2.2 m ³	1.9 m ³	1.9 m ³	1.9 m ³
Bucket width	2740 mm	2740 mm	2740 mm	2740 mm	2740 mm	2740 mm	2740 mm	2740 mm	2740 mm	2740 mm
Bucket weight	1330 kg	1445 kg	1370 kg	1260 kg	1260 kg	1260 kg	1260 kg	1255 kg	1255 kg	1255 kg
H Dumping clearance, max. height and 45° dump angle*	2880 mm	2745 mm	2965 mm	2785 mm	2785 mm	2785 mm	2785 mm	3525 mm	3525 mm	3525 mm
I Reach at max. height and 45° dump angle*	1000 mm	1110 mm	840 mm	1240 mm	1240 mm	1240 mm	1240 mm	980 mm	980 mm	980 mm
J Reach at 2130 mm clearance and 45° dump angle*	1595 mm	1620 mm	1540 mm	1765 mm	1765 mm	1765 mm	1765 mm	2060 mm	2060 mm	2060 mm
K Reach with arm horizontal and bucket level*	2500 mm	2665 mm	2350 mm	2735 mm	2735 mm	2735 mm	2735 mm	2825 mm	2825 mm	2825 mm
L Operating height (fully raised)	5375 mm	5465 mm	5175 mm	5425 mm	5425 mm	5425 mm	5425 mm	5845 mm	5845 mm	5845 mm
M Overall length (bucket on ground)	7690 mm	7855 mm	7540 mm	7840 mm	7840 mm	7840 mm	7840 mm	8125 mm	8125 mm	8125 mm
Loader clearance circle (bucket at carry, outside corner of bucket)	12620 mm	12715 mm	12500 mm	12655 mm	12655 mm	12655 mm	12655 mm	13010 mm	13010 mm	13010 mm
Digging depth: 0°	165 mm	165 mm	165 mm	65 mm	65 mm	65 mm	65 mm	270 mm	270 mm	270 mm
10°	375 mm	410 mm	350 mm	320 mm	320 mm	320 mm	320 mm	460 mm	460 mm	460 mm
Static tipping load: straight	11500 kg	11410 kg	11485 kg	11255 kg	11255 kg	11255 kg	11255 kg	9175 kg	9175 kg	9175 kg
40° full turn	9780 kg	9670 kg	9745 kg	9520 kg	9520 kg	9520 kg	9520 kg	7710 kg	7710 kg	7710 kg
Breakout force	162 kN	139 kN	185 kN	140 kN	140 kN	140 kN	140 kN	197 kN	197 kN	197 kN
	16470 kgf	14130 kgf	18870 kgf	14240 kgf	14240 kgf	14240 kgf	14240 kgf	20088 kgf	20088 kgf	20088 kgf
Operating weight	15480 kg	15600 kg	15520 kg	15870 kg	15870 kg	15870 kg	15870 kg	15680 kg	15680 kg	15680 kg

*At the end of tooth or B.O.C.E.

All dimensions, weights, and performance values based on SAE J732c and J742b standards. Static tipping load and operating weight shown include lubricant, coolant, full fuel tank, ROPS cab and operator. Machine stability and operating weight affected by tyre size and attachments.

FORK

	Fork With Quick Coupler
O Fork tine length	1524 mm
P Ground to top of tine at maximum lift	3855 mm
Q Reach at maximum lift	840 mm
R Ground to top of tine - boom and tine level	1845 mm
S Reach - boom and tine level	1730 mm
T Reach - tine level on ground	1060 mm
U Overall length - tine level on ground	8375 mm
Static tipping load - boom level:	straight 8550 kg
	40° full turn 7440 kg
Operating weight	15140 kg

Operating load per SAE J1197 (Feb. 1991), 50% of static tipping load.

Static tipping load and operating weight shown include lubricant, coolant, full fuel tank, ROPS cab and operator. Machine stability and operating weight affected by tyre size and attachments.

W4320-8



WEIGHT CHANGES

Tires or attachments	Change in operating weight	Change in tipping load		Width over tyres	Ground clearance	Change in vertical dimensions
		Straight	Full turn			
	kg	kg	kg	mm	mm	mm
Remove additional counterweight	-250	-440	-380	0	0	0



STANDARD EQUIPMENT

ENGINE:

- Automatic hydraulic-driven fan with automatic reverse rotation
- Engine Pre-cleaner, Turbo II
- Engine, Komatsu SAA6D107E-3 diesel
- Fuel pre-filter with water separator
- Komatsu SmartLoader Logic
- Radiator mask, swing up
- Radiator, wider core

ELECTRICAL SYSTEM:

- Alternator, 90 A, 24 V
- Batteries, 92 Ah/12 V (2), 680 CCA
- Komatsu Auto Idle Shutdown
- Lights
 - Back-up light
 - Flashing Beacon, LED with Guard
 - Stop and tail light
 - Turn signal, 2 front and 2 rear with hazard switch
 - Working lights, halogen, 2 front cab mount
 - Working lights, halogen, 2 front fender mount
 - Working lights halogen, 2 rear grill mount
- Starting motor, 5.5 kW

CAB:

- 2 x DC12V electrical outlets
- Auto air conditioner
- Colour LCD/TFT multi-monitor
- Door LH and RH egress
- Electronically Controlled Suspension System (ECSS)

- Equipment Management Monitoring System (EMMS)
 - Lights (central warning, brake oil pressure, engine oil pressure, parking brake, cooling fan reverse, KDPF restriction, seat belt caution, Komtrax message)
 - Gauges (engine water temperature, ecology, fuel level, DEF level, HST oil temperature, speedometer/tachometer), variable speed display
- Floor mat
- Operator seat, reclining, air suspensions type, heated
- Radio, AM/FM with AUX input jack
- Rear defroster, electric
- ROPS/FOPS Cab Level 2
- Seatbelt, 2-point retractable, 76mm width
- Steering wheel, tilt and telescopic
- Sun visor, front window
- Windshield washer and wiper, front with intermittent
- Windshield washer and wiper, rear

SAFETY EQUIPMENT:

- Back-up alarm
- Battery isolation switch
- Colour rear view camera and monitor
- Emergency stop switches (3)
- Horn, electric
- Overcentre Safety Valves (Coupler model only)
- Parking brake, electric
- Rear view mirrors, outside (2) inside (2)

- Service brakes, wet disk type
- Wheel chocks, steel type

TYRES:

- 20.5-R25 tyres

OTHER:

- 2-spool valve for boom and bucket, lever control
- 3-spool valve, lever control (will utilise integrated proportional control switch included in the multi-function mono-lever) and piping
- Automatic greasing system
- Boom kick-out, in-cab adjustable
- Bucket positioner
- Counterweight, standard and additional
- Front fenders
- KOMTRAX® Level 5
- Lift cylinders and bucket cylinder
- Loader linkage with standard lift arm
- Multifunction mono-lever loader control with transmission F/R switch (optional)
- Quick coupler (Coupler model only)
- Rear full fenders
- Transmission speed ranges, 4 forward and 4 reverse
- Vandalism protection kit, padlocks for battery box (2)



OPTIONAL EQUIPMENT

- Additional LED Lighting
- Bluetooth Media system
- Clean Air Cab Pressurisation systems
- Fire Extinguishers
- Fire Suppression systems
- Hi Vis Decals
- High-Lift Boom and bucket cylinder
- Limited slip differential (F&R)
- Powertrain Underguard
- Reverse Sensor
- SMART Alarm Broadband reverse alarm
- UHF/CB Radio
- Various bucket and fork options
- Various Scale Systems
- Window Tinting

